



Congratulations on the purchase of your new DMI Sports Table hockey table. Our products are designed and manufactured to give you years of game playing enjoyment.

KEEP BOX AND PACKING MATERIAL UNTIL TABLE HAS BEEN COMPLETELY ASSEMBLED.

ALL DAMAGE MUST BE REPORTED TO DMI WITHIN TEN DAYS OF RECEIPT.

If you have any problems with your new product,

PLEASE DO NOT RETURN IT TO THE STORE.

Please contact us:

1.800.399.4402

FAX: 215.283.9573

Please have your model number when inquiring about parts.

Or write to:

DMI Sports

Customer Service

375 Commerce Drive

Fort Washington PA, 19034

Please visit our web site at:

www.dmisports.com

When contacting DMI Sports, please provide your model number and item number (if applicable) if requesting a replacement part. Item numbers can be found inside this owners manual.

Your Model Number HT280

Your model number is also located on the original carton. These instructions are also available online at: www.dmisports.com.

IMPORTANT!

Please Keep Your Instructions! (You will need your Model number should you need to contact us.) Before attempting assembly, please read through this instruction book to familiarize yourself with all the parts and assembly steps. We recommend that two adults assemble this table. Please refer to the Parts Identifier on the following page and be sure that all parts have been included. Although extremely rare, occasionally a part may be missing. If you are missing a part, or if you have any questions, please call our customer service department at 1.800.399.4402 Mon-Fri between the hours of 9:00am and 5:00pm E.S.T; or you can reach us at: www.dmisports.com.

Do not return the game to the store. Please contact us first at: 1.800.399.4402 or on our website at: www.dmisports.com.

TWO ADULTS ARE REQUIRED TO ASSEMBLE THIS HOCKEY TABLE











TOOLS REQUIRED FOR ASSEMBLY:





- Allen Wrench- Included
- Wrench - Included
- Level recommended Not Included

PARTS IDENTIFIER

HARDWARE PARTS



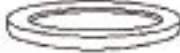







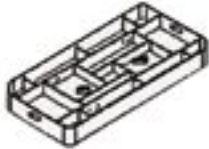

H1	Qty. 12	H2	Qty. 24	H3	Qty. 12	H4	Qty. 8
 3/8" Bolt RPHT280-3/8BOLT		 3/8" Washer RPHT280-3/8WASH		 3/8" Hex Nut RPHT280-3/8NUT		 1" Screw RPHT280-1SCREW	
H5	Qty. 8	H6	Qty. 16	H7	Qty. 24	H8	Qty. 16
 F4 Screw RPHT280-F4SCREW		 1/4" Allen Bolt RPHT280-1/4BOLT		 1/4" Washer RPHT280-1/4WASH		 1/4" Threaded Insert Nut RPHT280-1/4NUT	
H9	Qty. 2						
 Screw RPHT280-SCREW							

ACCESSORY PARTS

A1	Qty. 4	A2	Qty. 4	A3	Qty. 4	A4	Qty. 1
 Pusher RPHT-PUSH		 Felt Pad RPHT-FELT		 Goal Flex™ Puck RPHT-PUCK		 Wrench, Multi RPHT-MWRENCH	
A5	Qty. 1						
 1/4" Allen Tool RPHT-1/4TOOL							

PARTS IDENTIFIER

ASSEMBLY PARTS

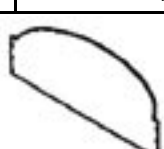
P1	Qty. 1	P2	Qty. 2	P3	Qty. 2	P4	Qty. 2
	Main Frame RPHT280-FRAME		Panel, Leg RPHT280-PANEL		Lock Bolt RPHT280-XBOLT		Right Leg RPHT280-RLEG
P5	Qty. 2	P6	Qty. 2	P7	Qty. 2	P8	Qty. 4
	Left Leg RPHT280-LLEG		Stretcher, Upper RPHT280-UPSTRCH		Stretcher, Lower RPHT280-LOWSTRC		Leg Base(Foot) RPHT280-FOOT
P9	Qty. 4	P10	Qty. 1	P11	Qty. 2	P12	Qty. 2
	Leg Leveler RPHT280-LEV		Slide Scorer RPHT280-SCORE		.25" x 3.5" Butterfly Bolt RPHT280-LGXBOLT		.25" x 2.5" Butterfly Bolt RPHT280-SMXBOLT
P13	Qty. 2	P14	Qty. 1				
	Support Pole RPHT280-XSUPP		Extreme Blind RPHT280-XBLIND				

ASSEMBLY

NOTE: Please leave Main Frame (P1) face down in the carton that it ships in until the legs are attached. All images are shown up-side-down until the table is turn up on its legs.

STEP 1.

To assemble each arched leg, secure Left Leg (P5) to the Right Leg (P4) with Upper Stretcher (P6) and Lower Stretcher (P7) by screwing 1/4" Bolts (H6) and 1/4" Washer (H7) into Threaded Insert Nuts (H8) as shown below. Note: (P7) has a slight curve along the outer edge and is intended to be the bottom support. Do not tighten until you have inserted the curved Leg Panel (P2). Once the Leg Panel has been positioned in place, tighten bolts and washers firmly.

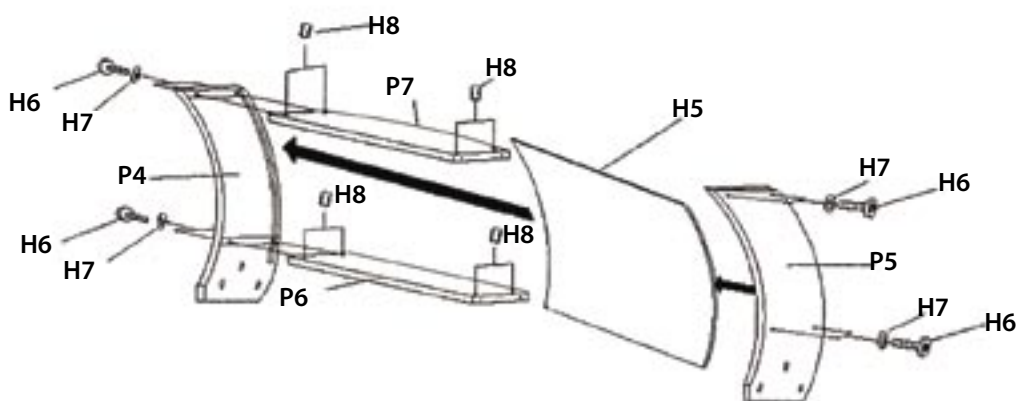
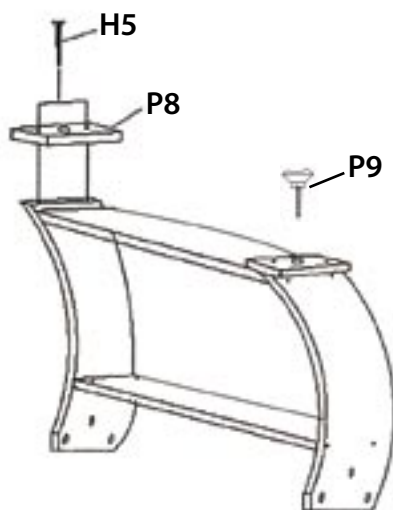

FIG 1.1

STEP 2.

Secure each Leg Base (P8) with F4 Screws (H5). Be sure to secure these Leg bases evenly on both sides of arched leg structure for best appearance.



IMPORTANT

When attaching Leg Base, make sure Leg Leveler (P9) will thread completely through Leg base and slot in leg.

FIG 2.1

ASSEMBLY

STEP 3.

Set each assembled leg structure between Main Frame (P1) support beams as indicated in Fig. 3.1 and secure tightly with Bolt (H1), Washer (H2) and Hex Nut (H3). **DO NOT STAND ON TABLE STRUCTURE TO POSITION LEG ASSEMBLY.** Screw in Leg Levelers (P9).

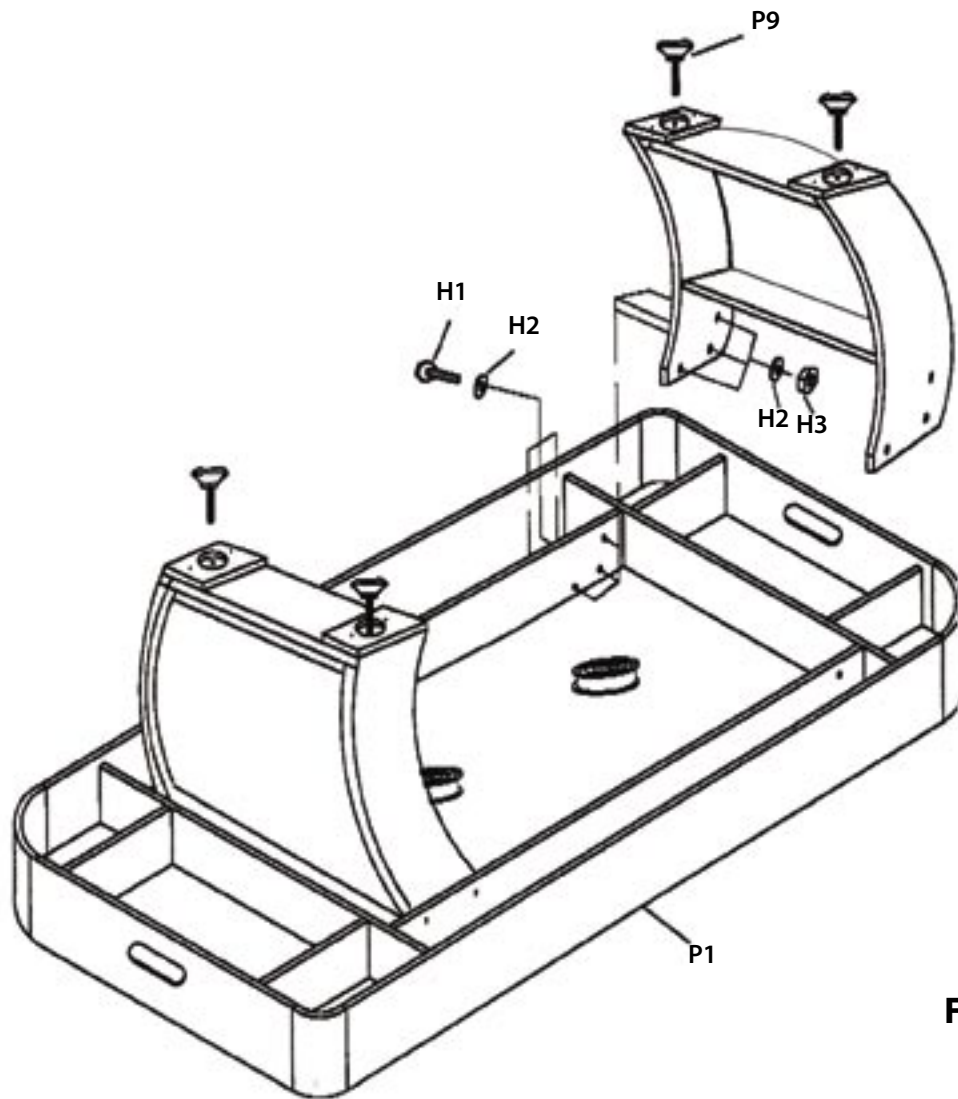

FIG 3.1

STEP 4.

With the assistance of at least one adult, gradually lift and turn your new Hockey Table over. Plug in the blow motor.

Attaching optional Extreme Hockey Blind.

Attach Support Poles (P13) with Butterfly Bolts (P11 and P12) to the side of your table as shown in Fig. 4.1. Install Lock Bolts (P3) into support poles with Screws (H9). Insert Extreme Blind (P14) between two Support Poles (P13).

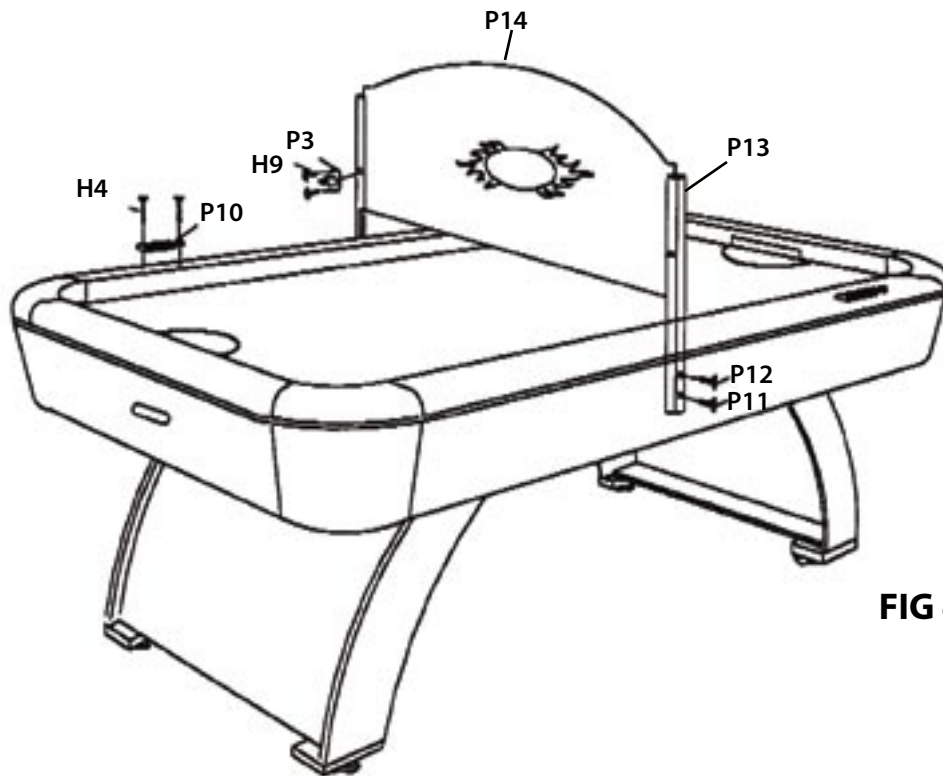
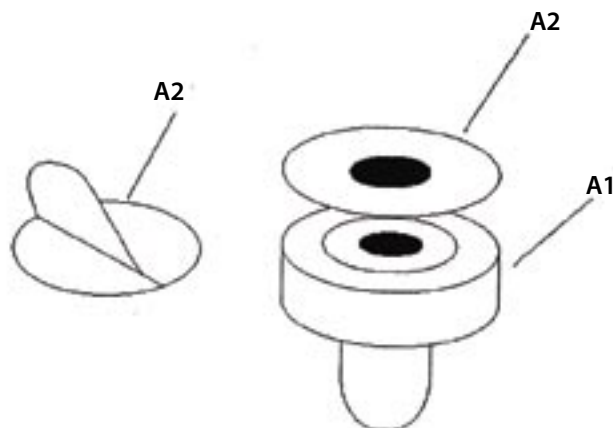

FIG 4.1

STEP 5.

Apply Felt Pads (A2) to the bottom of your Pushers (A1). Congratulations, you're ready to play!



PARTS RE-ORDER FORM**HT280 Table Hockey table**Send this form along with your
check or money order payable to:**DMI SPORTS**375 Commerce Drive
Fort Washington, PA 19034
www.dmisports.com

DATE: _____

NAME: _____

ADDRESS: _____ PHONE: _____

CITY: _____ STATE: _____ ZIP CODE: _____

REF	QTY	PART#	DESCRIPTION	UNIT PRICE	TOTAL AMOUNT
H1		RPHT280-3/8"BOLT	3/8" Bolt (ea.)	.25	
H2		RPHT280-3/8WASH	3/8" Washer (ea.)	.25	
H3		RPHT280-3/8NUT	3/8" Hex Nut (ea.)	.50	
H4		RPHT280-1SCREW	1" Screw (ea.)	.25	
H5		RPHT280-F4SCREW	F4 Screw (ea.)	.25	
H6		RPHT280-1/4BOLT	1/4" Allen Bolt (ea.)	1.00	
H7		RPHT280-1/4WASH	1/4" Washer (ea.)	.25	
H8		RPHT280-1/4NUT	1/4" Threaded Insert Nut (ea.)	.50	
H9		RPHT280-SCREW	Screw (ea.)	.25	
P1		RPHT280-FRAME	Main Frame (ea.)	N/A	
P2		RPHT280-PANEL	Panel, Leg (ea.)	15.00	
P3		RPHT280-XBOLT	Lock Bolt (ea.)	.75	
P4		RPHT280-RLEG	Right Leg (ea.)	20.00	
P5		RPHT280-LLEG	Left leg (ea.)	20.00	
P6		RPHT280-UPSTRCH	Stretcher, Upper (ea.)	15.00	
P7		RPHT280-LOWSTRC	Stretcher, Lower (ea.)	15.00	
P8		RPHT280-FOOT	Leg Base (Foot) (ea.)	7.50	
P9		RPHT280-LEV	Leg Leveler (ea.)	4.00	
P10		RPHT280-SCORE	Slide Scorer (ea.)	7.00	
P11		RPHT280-LGXBOLT	.25"x3.5" Butterfly Bolt (ea.)	.75	
P12		RPHT280-SMXBOLT	.25"x2.5" Butterfly Bolt (ea.)	.75	
P13		RPHT280-XSUPP	Support Pole (ea.)	5.00	
P14		RPHT280-XBLIND	Extreme Blind (ea.)	25.00	
A1		RPHT-PUSH	Pusher (ea.)	2.00	
A2		RPHT-FELT	Felt Pad (ea.)	1.00	
A3		RPHT-PUCK	Puck (ea.)	1.50	
A4		RPHT-MWRENCH	Multi Wrench (ea.)	2.00	
A5		RPHT-1/4TOOL	1/4" Allen Tool (ea.)	1.00	

SHIPPING AND HANDLING:**Subtotal:****Up to \$15.00 add \$2.00 for S&H****PA Residents Add 6% State Sales Tax:****Over \$15.00 add \$8.00 for S&H****Shipping and Handling Charges:****Console add \$5.00 for S&H****TOTAL:**