

# **GLD**®

## **P R O D U C T S**

### **Tirade Soccer Table**

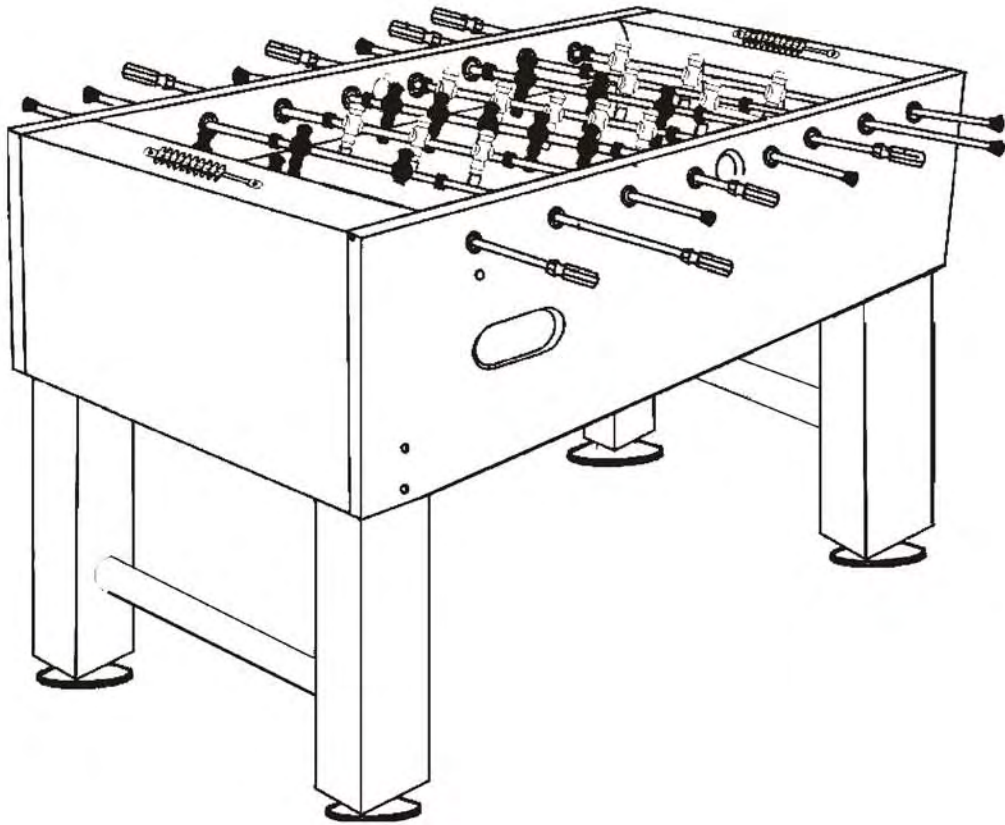

Item #64-0928

June 2006

UPC Code 7-19265-51305-6

**IMPORTANT: READ THIS MANUAL ALL THE WAY THROUGH BEFORE BEGINNING TO PUT YOUR GAME TABLE TOGETHER! THEN READ EACH STEP BEFORE STARTING THAT STEP.**

## **TWO ADULTS ARE REQUIRED TO ASSEMBLE THIS GAME TABLE.**

### **Tools Required:**

Allen Hex Wrench - Included with the table (#31)

Phillips screwdriver

Level

### **Assembly Tips**











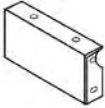
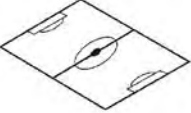

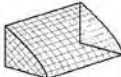

Make sure you understand the following tips before you begin to assemble your game table.



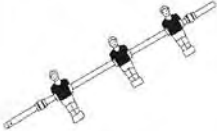
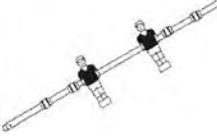
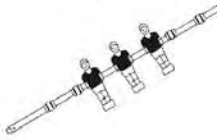
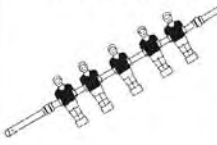
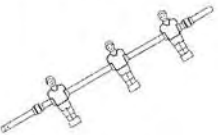
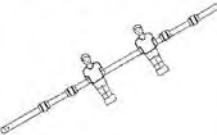
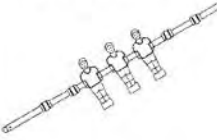
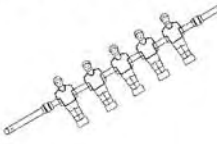

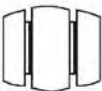





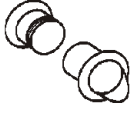

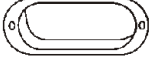

1. When installing parts that have more than one bolt, start ALL bolts in that part by hand before tightening anything.
2. Some drawings or images in this manual may not look exactly like your product. Please read and understand the text before starting each assembly step.

### **Care and Use of Your Table**

- Keep clean with a damp cloth.
- This product is intended for INDOOR use only.
- DO NOT sit, climb, or lean on the table.
- DO NOT drag the table when moving it. This will damage the legs.
- Apply silicon to a rag and wipe rods for better play.

# PARTS

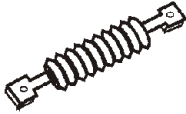
<p><b>#1</b></p>  <p>Side Apron (2)</p>	<p><b>#2</b></p>  <p>End Apron (2)</p>	<p><b>#3</b></p>  <p>Playfield (1)</p>	<p><b>#4</b></p>  <p>6 x 45mm Allen Key Bolt (8)</p>	<p><b>#5</b></p>  <p>Leg (4)</p>
<p><b>#6</b></p>  <p>Ball Return (2)</p>	<p><b>#7</b> Pre-Installed</p>  <p>Goal Box (2)</p>	<p><b>#8</b></p>  <p>8 x 40 mm Leg Bolt (16)</p>	<p><b>#9</b></p>  <p>Handle Grip (8)</p>	<p><b>#10</b></p>  <p>Leg Leveler (4)</p>
<p><b>#11</b></p>  <p>22 mm Washer (16)</p>	<p><b>#12</b> Pre-Assembled</p>  <p>3 Player Rod-Black (1)</p>	<p><b>#13</b> Pre-Assembled</p>  <p>2 Player Rod-Black (1)</p>	<p><b>#14</b> Pre-Assembled</p>  <p>3 Player Rod-Black (1)</p>	<p><b>#15</b> Pre-Assembled</p>  <p>5 Player Rod-Black (1)</p>
<p><b>#16</b> Pre-Assembled</p>  <p>3 Player Rod-Ivory (1)</p>	<p><b>#17</b> Pre-Assembled</p>  <p>2 Player Rod-Ivory (1)</p>	<p><b>#18</b> Pre-Assembled</p>  <p>2 Player Rod-Ivory (1)</p>	<p><b>#19</b> Pre-Assembled</p>  <p>5 Player Rod-Ivory (1)</p>	<p><b>#20</b> Pre-Installed</p>  <p>Player-Black (13)</p>
<p><b>#21</b> Pre-Installed</p>  <p>Player-Ivory (13)</p>	<p><b>#22</b> Pre-Installed</p>  <p>Rubber Bumper (16)</p>	<p><b>#23</b></p>  <p>End Cap (8)</p>	<p><b>#24</b></p>  <p>3.5 x 10.5 mm Washerhead Screw (14)</p>	<p><b>#25</b></p>  <p>3.5 x 25 mm Philips Screw (4)</p>

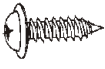
<p><b>#26</b></p>  <p>Ball Entry Cup (2)</p>	<p><b>#27</b></p> <p>Pre-Installed</p>  <p>2-Piece Player Rod Bushing (16)</p>	<p><b>#28</b></p>  <p>18mm Washer (8)</p>	<p><b>#29</b></p>  <p>Soccer Ball (4)</p>
<p><b>#30</b></p> <p>Pre-Installed</p>  <p>Side Ball Return Ring (2)</p>	<p><b>#31</b></p>  <p>5mm Allen Hex Wrench (1)</p>	<p><b>#32</b></p>  <p>Leg Brace (2)</p>	<p><b>#33</b></p>  <p>Support Rod Nut (4)</p>
<p><b>#34</b></p>  <p>Wooden Support (2)</p>	<p><b>#35</b></p>  <p>Support Rod (2)</p>	<p><b>#36</b></p>  <p>Scorekeeper-Black (1)</p>	<p><b>#37</b></p> <p>Pre-Installed</p>  <p>F Channel (2)</p>
<p><b>#38</b></p>  <p>Scorekeeper-Ivory (1)</p>	<p><b>#39</b></p>  <p>Enterising Board (4)</p>	<p><b>#40</b></p>  <p>3.5 x 7 mm Washer Head Screw (4)</p>	

## ASSEMBLY

Start with one of the table sides. The rods have the players attached.

### STEP 1

Handles for Ivory  
players on this side.

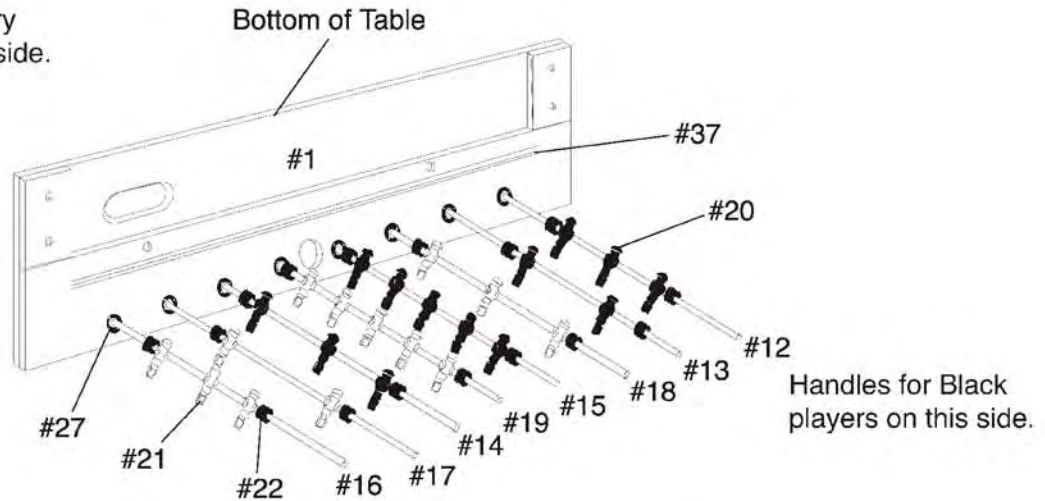

Handles for Black  
players on this side.

Figure 1

- Lay the player rods (12 thru 19) on the floor in the order shown. The color and number of players on each rod should be followed. Player rods 12 and 16 have the players further apart than player rods 14 and 18.
- The player rods have a bolt hole in one end. Position the ivory player rods so the bolt handle hole is on side (1) of the table and the holes in the black player rods are on side (2).
- The rod handles and end caps will be installed later.

### STEP 2

- Working upside down, position one of the table sides (1) top edge down next to one end of the player rods.
- Each rod hole in the table side must have a preinstalled bushing (27).
- Slide the player rods into the holes of the table side (1). Make sure the pre-installed rubber bumpers (22) are still in place on both sides of the rod.

### STEP 3

- Position the second table side (1) top edge down and playing field slot inward on the second side of the player rods.
- Slide the player rods into the holes of the table side (1).

## STEP 4

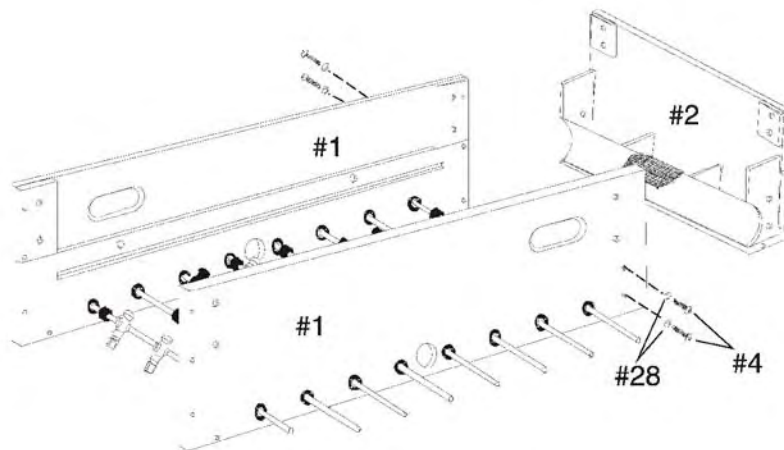

Figure 2

- Position one of the end aprons (2) top edge down at one end of the assembly and position it against one of the sides (1).
- Use two of the allen bolts (4) and two washers (28) to secure the two pieces. Tighten part way.
- Use two additional allen bolts (4) and washers (28) to secure the opposite side to the same end apron (2).

## STEP 5

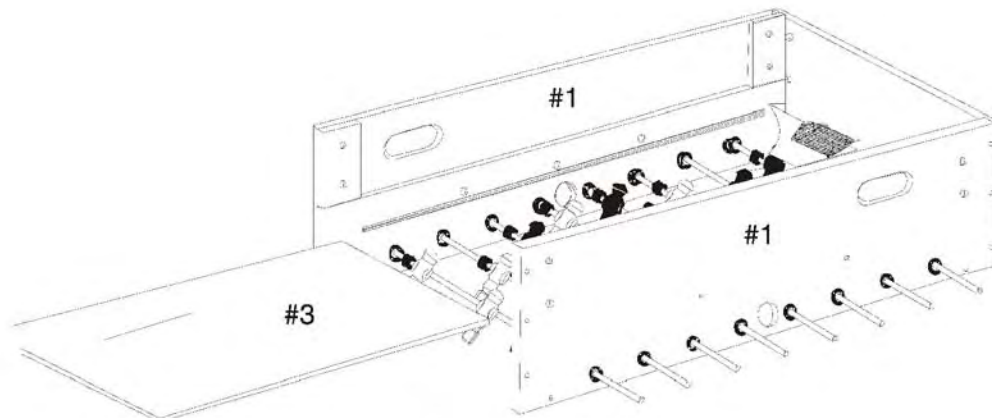

Figure 3

- Turn the playfield (3) face down. Position the playfield (3) in the F-channel slots (37) of the sides (1) and push the two sides toward each other. This will trap the playfield (3).

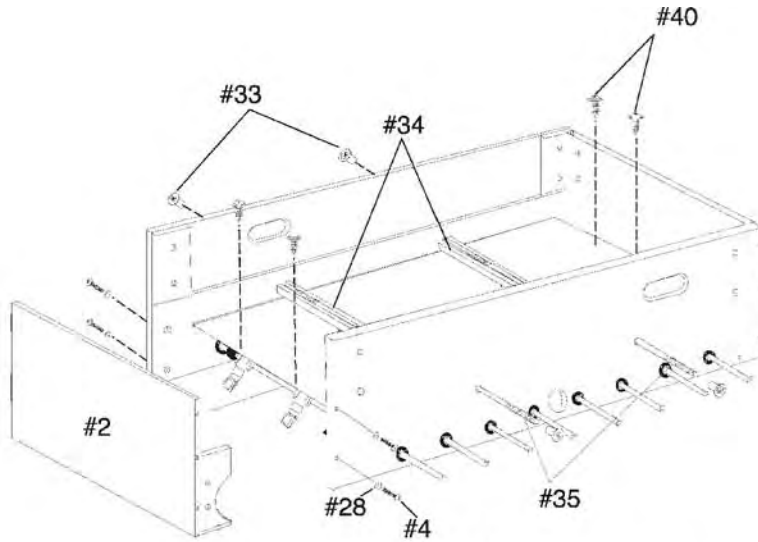

Figure 4

- Position the second end apron (2) top edge down at the open end of the assembly.
- Use two allen bolts (4) and washers (28) on each side. Tighten part-way.
- Place the two wooden supports (34) on the playfield (3). The open side should face up, away from the playing field.
- Insert the two support rods (35) into the holes in the table side. Position the wooden supports (34) so the rods (35) will be in the slot when the rods are pushed in.
- Screw one support rod nut (33) onto the end of each rod (35). Push the rod inward so the rod goes into the hole on the second side.
- Screw the second support rod nut (33) onto the rod. Hold one support rod nut and tighten the other one until the two sides (1) are tight to the playfield (3).
- Secure the end apron (2) by tightening the eight allen bolts (4).
- To secure the ends of the playfield (3) to the end aprons (2), use four screws (40) at each end.

## STEP 6

Attach the legs (5) with leg brace (32).

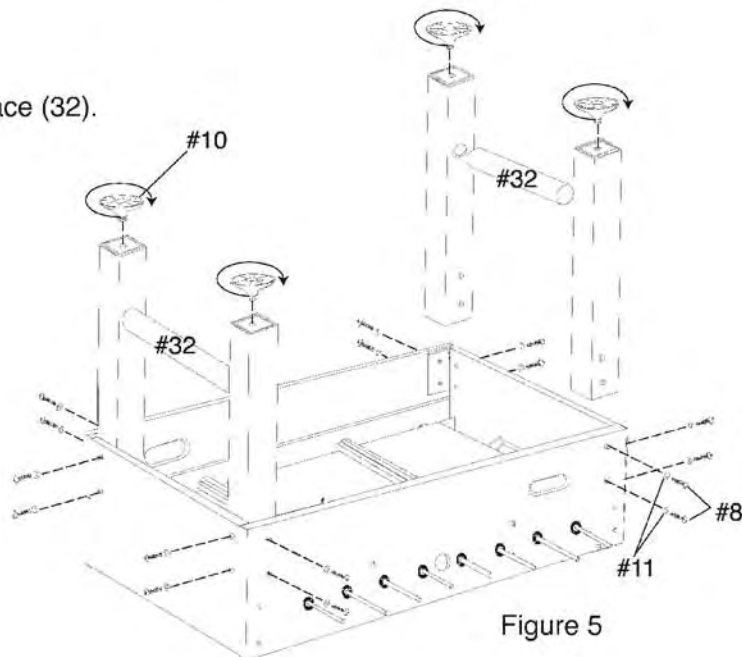

Figure 5

- Position the first leg (5) into the proper corner. The hole for the leg brace (32) faces toward the other leg and the four screw holes align with the screw holes in the sides.
- Insert four leg bolts (8) with washers (11) into the holes and finger start into the leg (5).
- Tighten the leg bolts.
- Position the second leg (5) at the same end.
- Place the leg brace (32) in the holes of the two legs.
- Insert four leg bolts (8) with washer (11) into the holes and finger start into the leg (5).
- Tighten the leg bolts.
- Repeat for other two legs.
- Screw a leg leveler (10) halfway into the bottom of each leg.

## STEP 7

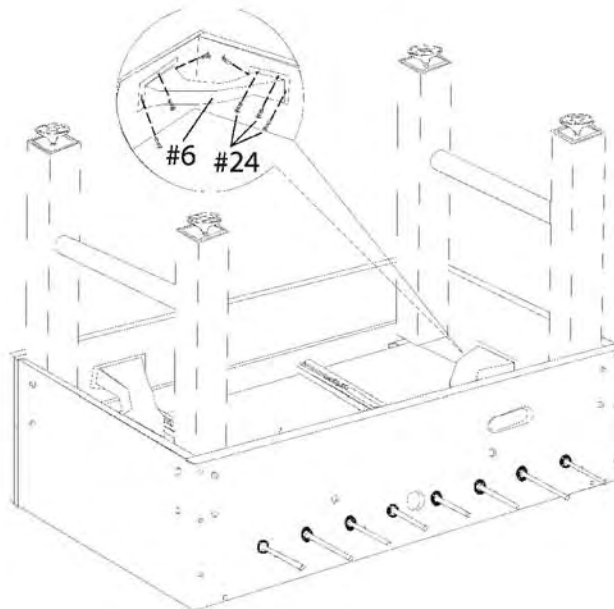

Figure 6

Install the two ball returns (6).

- Position the ball return (6). Observe the number and location of the seven screw holes.
- Insert a screw (24) in each hole and tighten.
- Repeat for second ball return.

Turn the table over. Two adults should perform this action. The player rods will shift but will not fall out.

## STEP 8

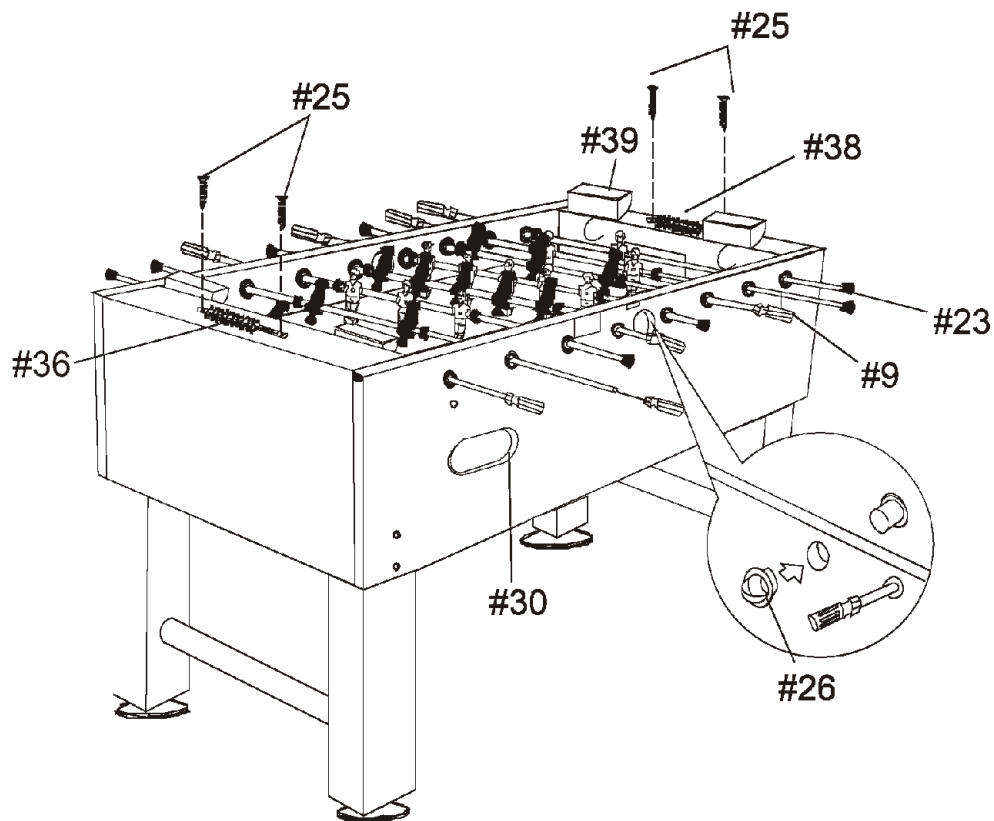

Figure 7

- Slide a handle grip (9) onto the player rod.
- Repeat for the remaining player rods on both sides of the table.
- Place an end cap (23) on the opposite ends of the player rods and press in place.
- Install the two ball entry cups (26) one on each side.
- The cup is on the outside of the table and the opening faces up. Screw the two pieces together.
- Install the black scorekeeper (36) on the top of the table behind the black goalie.
- Position the scorekeeper (36) and finger start two screws (25).
- Tighten the screws.
- Repeat for the ivory scorekeeper (38).
- Install the four optional enterprizing boards (39).

Position the table in the room and level. To level the table place a carpenters level on the top edges and turn the leg levelers (10) in or out as needed.

## Parts Re-Order Form Soccer Table, 64-0928

Name	Date
Address	Phone-Day
City	Phone-Evening
State	Zip
	Email

Part #	Description	Unit Price Ea. Pc.	Qty.	Total Amount
64-0928-01	Side Apron	50.00 ea.		
64-0928-02	End Apron	40.00 ea.		
64-0928-03	Playfield	30.00		
64-0928-04	6 x 45 mm Bolt	0.50 ea.		
64-0928-05	Leg	20.00 ea.		
64-0928-06	Ball Return	10.00 ea.		
64-0928-07	Goal Box	15.00 ea.		
64-0928-08	8 x 40 mm Leg Bolt	0.50 ea.		
64-0928-09	Handle Grip	10.00 ea.		
64-0928-10	Leg Leveler	10.00 ea.		
64-0928-11	<b>22 mm Washer</b>	0.50 ea.		
64-0928-12	3 Player Rod	16.00 ea.		
64-0928-13	2 Player Rod	16.00 ea.		
64-0928-15	5 Player Rod	16.00 ea.		
64-0928-20	Player - Black	5.00 ea.		
64-0928-21	Player - Ivory	5.00 ea.		
64-0928-22	Rubber Bumper	1.50 ea.		
64-0928-23	End Cap	1.00 ea.		
64-0928-24	3.5 x 10.5 mm Washer Head Screw	0.25 ea.		
64-0928-25	3.5 x 25 mm Philips Screw	0.25 ea.		
64-0928-26	2-piece, Ball Entry Cup	7.50 ea.		
64-0928-27	2-piece, Player Rod Bushing	7.50 ea.		
64-0928-28	18 mm Washer	0.50 ea.		
64-0928-29	Soccer Ball, 4pk.	5.00/pk.		
64-0928-30	Side Ball Return Ring	7.50 ea.		
64-0928-31	5 mm Allen Hex Wrench	1.00 ea.		
64-0928-32	Leg Brace	15.00 ea.		
64-0928-33	Support Rod Nut	0.50 ea.		
			Subtotal	
			S/H	
			Tax*	
			Total	

Part #	Description	Unit Price Ea. Pc.	Qty.	Total Amount
64-0928-34	Wooden Support	10.00 ea.		
64-0928-35	Support Rod	6.00 ea.		
64-0928-36	Scorekeeper - Black	10.00 ea.		
64-0928-37	F Channel	6.00 ea.		
64-0928-38	Scorekeeper - Ivory	10.00 ea.		
64-0928-39	Enterprising Board	10.00 ea.		
64-0928-40	3.5 x 7 mm Washer Head Screw	0.25 ea.		
			Subtotal	
			S/H	
			Tax*	
			Total	

**Shipping and Handling Charges**

Orders up to \$25.00	\$5.95
\$25.01 to \$50.00	\$8.95
\$50.01 to \$75.00	\$11.95
\$75.01 to \$150.00	\$15.95
\$150.01 to \$300.00	\$20.95

\*Wisconsin Residents: please apply tax percentage based on your county

**Method of Payment**

\_\_\_\_\_ Check or Money Order  
 \_\_\_\_\_ Credit Card  
 \_\_\_\_\_ Visa \_\_\_\_\_ MasterCard \_\_\_\_\_ Discover \_\_\_\_\_ American Express

Card # \_\_\_\_\_

Toll Free Customer Service phone number on back of card \_\_\_\_\_

Signature \_\_\_\_\_ Exp. Date \_\_\_\_\_

**Shipping Address**

Name \_\_\_\_\_

Address \_\_\_\_\_ Phone \_\_\_\_\_

City \_\_\_\_\_ State \_\_\_\_\_ Zip \_\_\_\_\_

**Mail To:**  
64-0928

## **GLD Products**

S84 W19093 Enterprise Drive  
Muskego, WI 53150 USA  
800-225-7593 • FAX 800-841-6944  
Email: [gld@gldmfg.com](mailto:gld@gldmfg.com)  
Web Site: [www.gldproducts.com](http://www.gldproducts.com)

# **WARRANTY**

Manufacturer warrants to the original retail purchaser, this product to be free from defects in material and workmanship for a period of ninety (90) days from the date of purchase.

Should this product become defective due to material or workmanship within the warranty period, contact our Customer Service Department. This warranty is not transferable and does not cover normal wear and tear, or damage caused by improper handling, installation, or use of this product. This warranty is also void if product is in any way abused, damaged, or modified from its original state, or if used for other than indoor residential use. This warranty gives you specific legal rights, and you may have other rights which vary from state to state.

## **DO NOT RETURN TO STORE**

For all returns and warranty coverage, please call:  
GLD Products 1-800-225-7593

Please provide model number, serial number and/or part number when you call. Numbers can be found on outside of packaging.

## **GLD Products**

S84 W19093 Enterprise Drive  
Muskego, WI 53150 USA  
800-225-7593 • FAX 800-841-6944  
Email: [gld@gldmfg.com](mailto:gld@gldmfg.com)  
Web Site: [www.gldproducts.com](http://www.gldproducts.com)